







-  shiny silver
-  rose gold
-  gold
-  bright black
-  matt black
-  matt white

LATTICE TRIMLESS



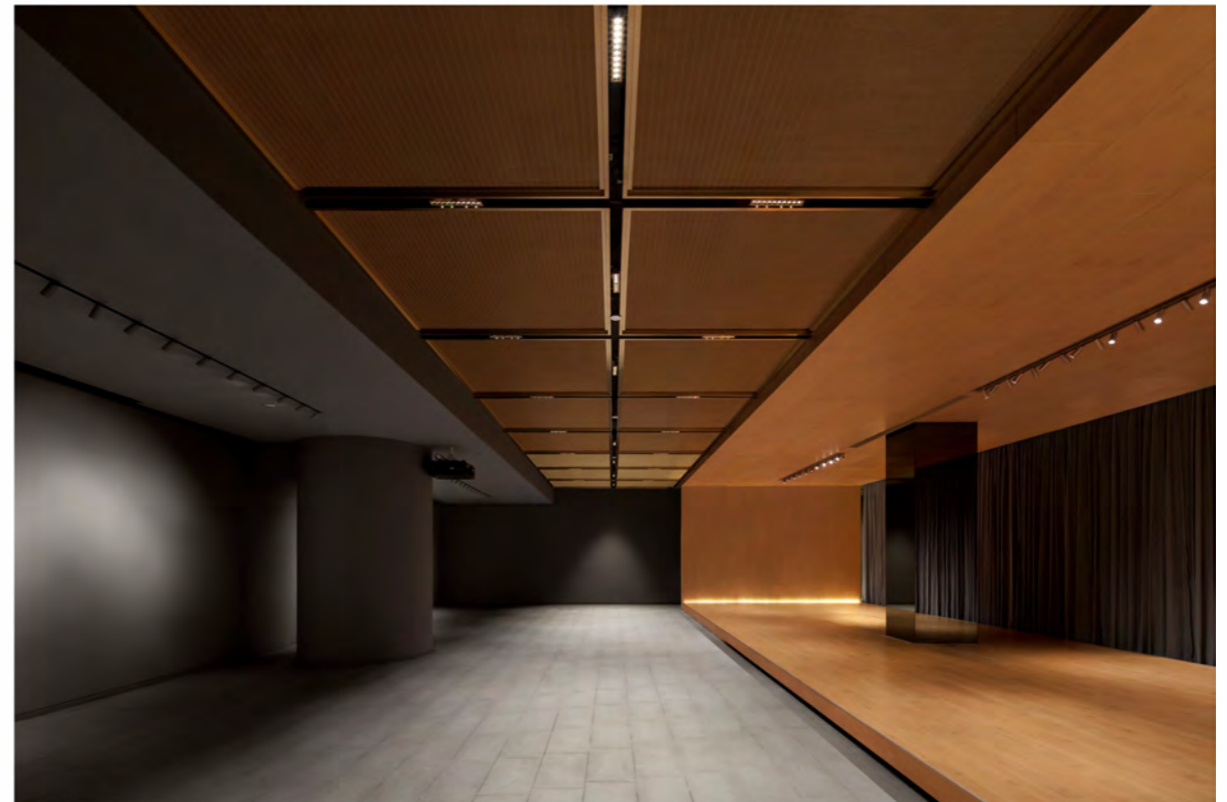

LATTICE TRIMLESS		01:180B02000
Power		4W
Beam angle		22°/36°/45°
Color temperature		2700K/3000K/3500K/4000K
Light efficiency		62lm/W
Color rendering index		≥90
Operating temperature		-25°C - 50°C
Rated life hours		35,000-50,000h LM80
LED chip		SMD

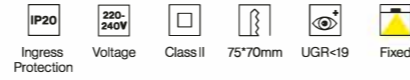

LATTICE TRIMLESS		01:180B03000
Power		6W
Beam angle		22°/36°/45°
Color temperature		2700K/3000K/3500K/4000K
Light efficiency		63lm/W
Color rendering index		≥90
Operating temperature		-25°C - 50°C
Rated life hours		35,000-50,000h LM80
LED chip		SMD



LATTICE TRIMLESS		01:180B05000
Power		10W
Beam angle		22°/36°/45°
Color temperature		2700K/3000K/3500K/4000K/2700K-6000K
Light efficiency		73lm/W
Color rendering index		≥90
Operating temperature		-25°C - 50°C
Rated life hours		35,000-50,000h LM80
LED chip		SMD

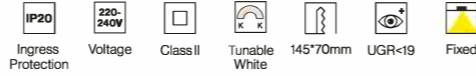

LATTICE TRIMLESS		01:180B10000
Power		20W
Beam angle		22°/36°/45°
Color temperature		2700K/3000K/3500K/4000K/2700K-6000K
Light efficiency		79lm/W
Color rendering index		≥90
Operating temperature		-25°C - 50°C
Rated life hours		35,000-50,000h LM80
LED chip		SMD



COLOUR | BK ■ WH □ | MATERIAL | AL | ABS+PC



LATTICE TRIMLESS		01:180B15000
Power		30W
Beam angle		22°/36°/45°
Color temperature		2700K/3000K/3500K/4000K/2700K-6000K
Light efficiency		78lm/W
Color rendering index		≥90
Operating temperature		-25°C - 50°C
Rated life hours		35,000-50,000h LM80
LED chip		SMD



OPTIONS

1	Non-DIM
2	TRIAC
3	0/1-10V
4	DALI
5	BLE
6	ZIGBEE

ACCESSORIES

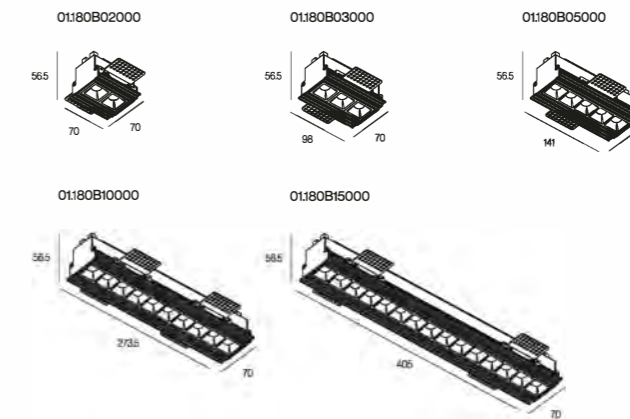
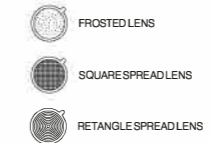

COLOUR | BK ■ WH □ | MATERIAL | AL | ABS+PC